

SE367 HW1

Instructor: Dr. Amitabha Mukerjee

-Anurag Sai

-Era Jain

-Pratyush Sinha

-Rajiv Omar

-Rohinish Gupta

Searle's Argument

- Computer programs are syntactic i.e. they just manipulate symbols based on rules.
- Human Minds have mental content(semantics)
- Syntax by itself is neither constitutive nor sufficient for semantics.

Basically Searl stresses on the point that there is a distinction between formal elements, which have no intrinsic meaning or content, and those phenomena that have *intrinsic* content.

Harnad in his paper deals 'The Symbol Grounding Problem' tries to model a system that is the hybrid of a symbolic system and a connectionist symbol so as to address the question of *intrinsic* meaning.

Searle says that neurons too just do symbol manipulations

Searle's Argument

- Computer programs are syntactic i.e. they just manipulate symbols based on rules.
- Human Minds have mental content(semantics)
- Syntax by itself is neither constitutive nor sufficient for semantics.

Basically Searl stresses on the point that there is a distinction between formal elements, which have no intrinsic meaning or content, and those phenomena that have *intrinsic* content.

Harnad in his paper deals 'The Symbol Grounding Problem' tries to model a system that is the hybrid of a symbolic system and a connectionist symbol so as to address the question of *intrinsic* meaning.

Searle says that neurons too just do symbol manipulations

But if a neural network just did symbol manipulations, how did neurons learn through experience ? Isn't it akin to a changing rulebook ?

Searle's Argument

- Computer programs are syntactic i.e. they just manipulate symbols based on rules.
- Human Minds have mental content(semantics)
- Syntax by itself is neither constitutive nor sufficient for semantics.

Basically Searle stresses on the point that there is a distinction between formal elements, which have no intrinsic meaning or content, and those phenomena that have *intrinsic* content.

Harnad in his paper deals 'The Symbol Grounding Problem' tries to model a system that is the hybrid of a symbolic system and a connectionist symbol so as to address the question of *intrinsic* meaning.

Searle says that neurons too just do symbol manipulations

But if a neural network just did symbol manipulations, how did neurons learn through experience ? Isn't it akin to a changing rulebook ?

What if feedback is incorporated in the rulebook ?

Searle's Argument

- Computer programs are syntactic i.e. they just manipulate symbols based on rules.
- Human Minds have mental content(semantics)
- Syntax by itself is neither constitutive nor sufficient for semantics.

Basically Searle stresses on the point that there is a distinction between formal elements, which have no intrinsic meaning or content, and those phenomena that have *intrinsic* content.

Harnad in his paper deals 'The Symbol Grounding Problem' tries to model a system that is the hybrid of a symbolic system and a connectionist symbol so as to address the question of *intrinsic* meaning.

Searle says that neurons too just do symbol manipulations

But if a neural network just did symbol manipulations, how did neurons learn through experience ? Isn't it akin to a changing rulebook ?

What if feedback is incorporated in the rulebook ?



The Kangaroo Pen example.

What is it that we expect of an intelligent system ?

Looking from a behaviorist POV since Harnad had already constrained his discussion to that

What is it that we expect of an intelligent system ?

Looking from a behaviorist POV since Harnad had already constrained his discussion to that

Considering language, if a computer could give a reasonable response to every question that we ask it, wouldn't it be intelligent ?

This line of thinking was similar to Turing Test

What is it that we expect of an intelligent system ?

Looking from a behaviorist POV since Harnad had already constrained his discussion to that

Considering language, if a computer could give a reasonable response to every question that we ask it, wouldn't it be intelligent ?

This line of thinking was similar to Turing Test

Considering the basic question of the discussion, whether computers, when they attempt to understand natural language, should use symbols that have meanings or not.

What is it that we expect of an intelligent system ?

Looking from a behaviorist POV since Harnad had already constrained his discussion to that

Considering language, if a computer could give a reasonable response to every question that we ask it, wouldn't it be intelligent ?

This line of thinking was similar to Turing Test

Considering the basic question of the discussion, whether computers, when they attempt to understand natural language, should use symbols that have meanings or not.

What is understanding ?

-Ability to reply to questions. Ex - Cleverbot

-Ability to make judgements, think and provide creative

-The latter, we thought are higher functions that should not be brought into the discussion on the basic concept of 'understanding' a natural language.

- We also considered that replying doesn't need to happen in the same language.

Rather there just need to be a syntactically correct response.

What is it that we expect of an intelligent system ?

Looking from a behaviorist POV since Harnad had already constrained his discussion to that

Considering language, if a computer could give a reasonable response to every question that we ask it, wouldn't it be intelligent ?

This line of thinking was similar to Turing Test

Considering the basic question of the discussion, whether computers, when they attempt to understand natural language, should use symbols that have meanings or not.

What is understanding ?

-Ability to reply to questions. Ex - Cleverbot

-Ability to make judgements, think and provide creative

-The latter, we thought are higher functions that should not be brought into the discussion on the basic concept of 'understanding' a natural language.

- We also considered that replying doesn't need to happen in the same language.

Rather there just need to be a syntactically correct response.

In case of humans, we use language to convey a certain sensory perception to another human.

To a computer, natural language would only be text symbols or audio symbols.

To a computer, natural language would only be text symbols or audio symbols.

But then isn't it just about the physical hardware ? If a computer was mounted on a robot that had the ability to see, touch, smell, hear and taste. Wouldn't in that case, combined with the ability to learn, the computer be able to reproduce a certain state that would correspond to understanding what is written in the text.
Here we were trying to use Harnad's model on an advanced kind of robot.

To a computer, natural language would only be text symbols or audio symbols.

But then isn't it just about the physical hardware ? If a computer was mounted on a robot that had the ability to see, touch, smell, hear and taste. Wouldn't in that case, combined with the ability to learn, the computer be able to reproduce a certain state that would correspond to understanding what is written in the text.
Here we were trying to use Harnad's model on an advanced kind of robot.

We have reached here an argument which Searle says people use against his theory (listed as f.). He refutes this line of thinking but has not given reasons for doing so.

However, Searle does say that being able to simulate hydrocarbon ignition or the human digestive system on a computer doesn't actually mean we can run a car or digest a pizza.

To a computer, natural language would only be text symbols or audio symbols.

But then isn't it just about the physical hardware ? If a computer was mounted on a robot that had the ability to see, touch, smell, hear and taste. Wouldn't in that case, combined with the ability to learn, the computer be able to reproduce a certain state that would correspond to understanding what is written in the text.
Here we were trying to use Harnad's model on an advanced kind of robot.

We have reached here an argument which Searle says people use against his theory (listed as f.). He refutes this line of thinking but has not given reasons for doing so.

However, Searle does say that being able to simulate hydrocarbon ignition or the human digestive system on a computer doesn't actually mean we can run a car or digest a pizza.

Here we thought whether intelligence shouldn't be related to the hardware present in the system ?

-Just like a system with different senses could understand better in our opinion, so could a system with the requisite hardware perform the tasks that the computer was simulating.

-A person with a hand cut-off still feels pain in it. So a computer does simulate tasks that have no physical significance until it is provided with that hardware.

Nature of a Linguistic Sign

- Ready-made ideas exist before words
- Linguistic entity unites not a thing and a name but a concept and “sound-image”

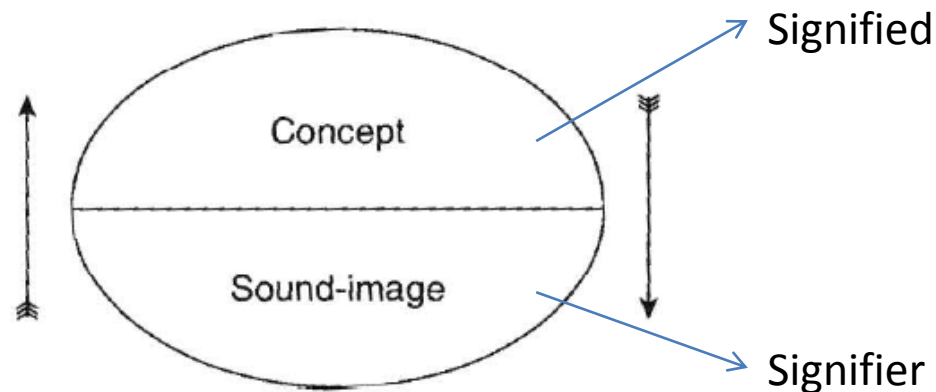

- Linguistic system: Series of different sounds (perceptions) linked with a series of different ideas

Only associations sanctioned by language exist in our reality and whatever else might be imagined, is ignored??

Discriminations help in categorization for some point of time but eventually you have to associate a linguistic label to the category!

Symbol grounding and Theft Hypothesis

- Understanding linguistic evolution can throw light on evolution of cognitive abilities
- Constituents of a communication system (Pierce, 1978)
 - **Icon:** Associate to an object based on physical resemblance to it
 - **Index:** Associated due to space/time contiguity (Animals – Single reference)
 - **Symbols:** Associate by social convention or implicit agreement (Double referential relationships – indexical link to a referent and logical relation with other symbols)
- Symbol Grounding Problem
 - Iconic representation + Categorical representation (“warped” transformation)
 - Define few set of basic words/symbols + syntactic rules to connect them
 - Infinite regression problem: Chinese Room argument
 - Symbols directly grounded to cognitive representations
 - “Zebra” = “Horse” + “stripes” (Symbol Theft)

Are “warped” transformations effected by the linguistic labels assigned to various categories?

Symbol grounding and Theft Hypothesis

- Connectionism – Artificial Neural nets as cognitive models
 - Good at categorization – Can replicate warped transformations (CP effect)
 - Many models built using them confirm several neurological aspects
 - Show Discrimination (Iconic) and Identification (Categorical)

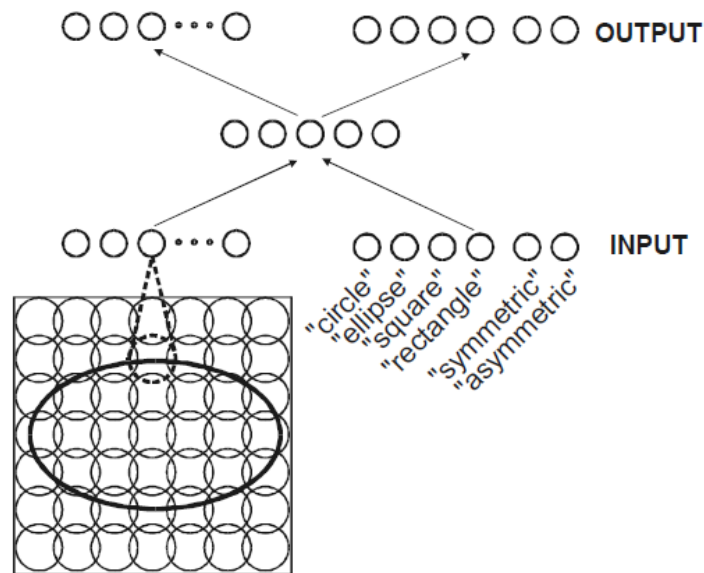



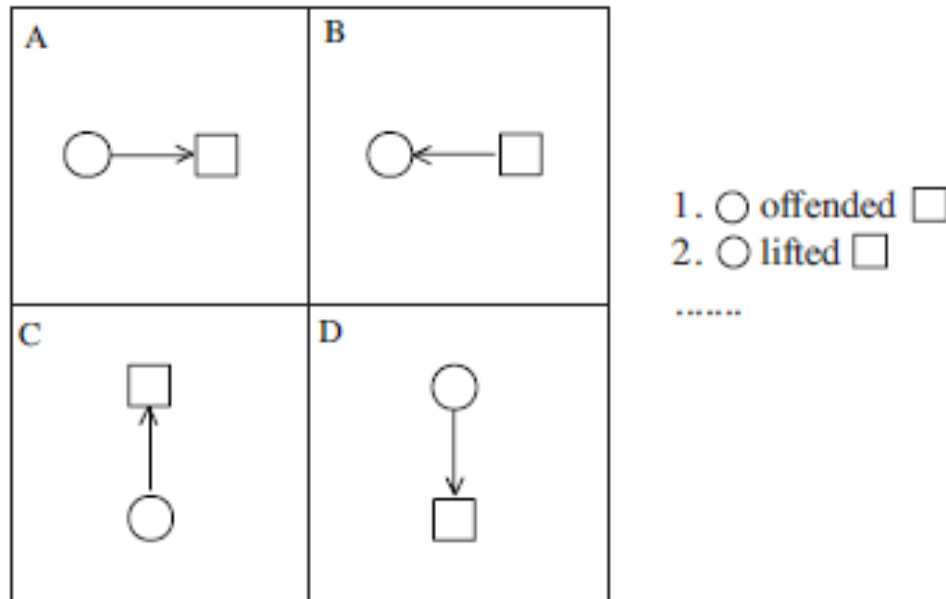

How does an infant ground the symbols. Unlike the experiments conducted on neural nets, the scenario is more complex. Can it be simulated?

“Language is Spatial”: Experimental Evidence for Image Schemas of Concrete and Abstract Verbs

- Language is encoded in mind in the form of spatial representations that are grounded in perception and action
- Is there a commonality in the spatial representations across various speakers?
- Consistency observed in descriptions of *Concrete* and *Abstract* verbs



Concreteness	Expected Axis	Verb				
			Up	Down	Left	Right
HIGH	Horizontal	fled	7.2	4.2	80.8	7.8
		pointed at	7.2	3.6	0	89.2
		pulled	6	5.4	75.4	13.2
		pushed	7.2	3.6	1.2	88
		walked	9	3.6	24	62.9
	Neutral	hunted	9.6	20.4	1.8	68.3
		impacted	7.2	37.1	3	52.7
		perched	12	76	6.6	5.4
		showed	15	9	10.2	65.9
		smashed	3.6	66.5	1.2	28.7
	Vertical	bombed	4.8	86.8	1.8	6.6
		flew	37.7	44.3	15	3
		floated	32.9	56.3	7.8	3
		lifted	87.4	9.6	2.4	0.6
		sank	22.2	71.9	4.2	1.8
LOW	Horizontal	argued with	11.4	13.8	12.6	62.3
		gave to	8.4	9.6	1.2	80.8
		offended	9	31.7	24.6	34.7
		rushed	10.2	10.8	23.4	55.1
		warned	10.8	22.2	6	61.1
	Neutral	owned	5.4	55.7	18.6	20.4
		regretted	19.8	24	41.3	15
		rested	14.4	36.5	40.1	9
		tempted	16.8	11.4	45.5	26.3
		wanted	15.6	7.8	15.6	61.1
	Vertical	hoped	45.5	15.6	7.2	31.7
		increased	73.7	7.2	9.6	9
		obeyed	22.8	4.2	64.7	8.4
		respected	53.9	3	14.4	28.7
		succeeded	40.1	35.9	10.8	13.2
		Means	20.9	26.2	19	33.8

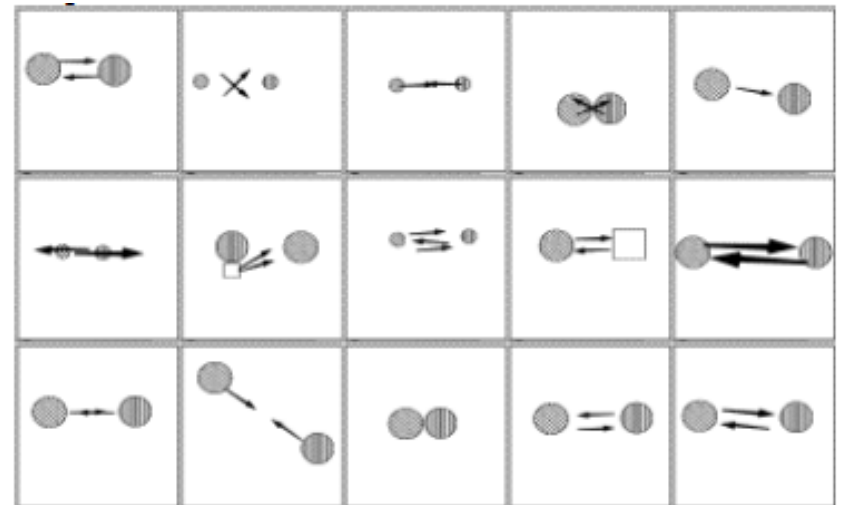

Figure 3: Example depictions of “ARGUED WITH”.

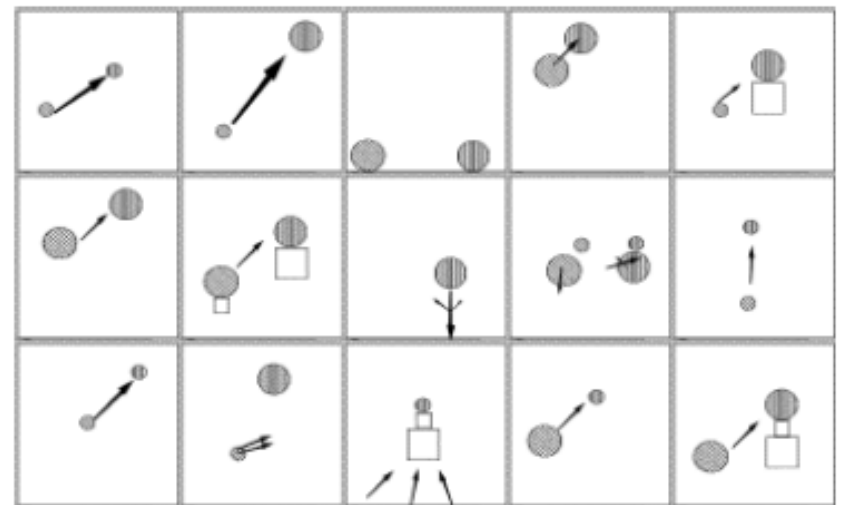

Figure 4: Example depictions of “RESPECTED”.

THANK YOU

Questions??